

Are you ready? Let's go sew!

www.letsdosew.com

Style Tip: Circular, spiral sleeve ruffles are easy to make using a circular sewing attachment. These soft ruffles make a beautiful addition to the edge of the sleeves on this lightweight tunic style swimsuit cover-up.

Presented by: Joanne Banko on [It's Sew Easy TV](#)



Sewing perfect circles is easy with the circular sewing attachment. You'll find many creative ways to use this attachment for decorative effects, or for a practical application like the sleeve ruffles featured here. Start with a basic tunic top modified to fit as a swimsuit cover-up, and then add soft, circular ruffles to the sleeves. Dress your best as you travel to the beach or pool!

More about the Circular Attachment Bundle:

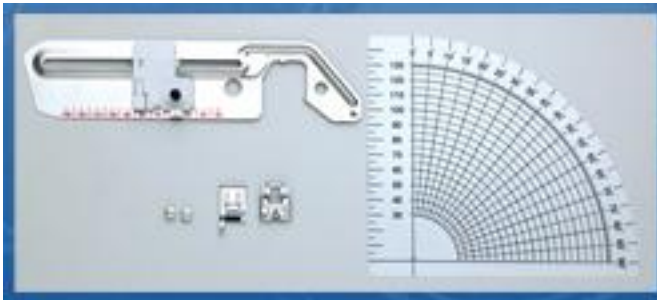

Create precise circles with radii ranging from 30mm to 130mm with this easy to use sewing attachment. Select a wide variety of stitches, including straight, zigzag, and decorative stitches. Complete instructions are included in the packages. You'll find the circular attachment is easy to set up and easy to use!

Tunic Top with Circular Sleeve Ruffle

Materials and Supplies featured in this episode:

- [Brother Sewing Machine](#) with circular sewing capability. **Note:** Click on the accessory link below to find a complete list of compatible models.
- [SACIRC1](#) Brother Circular Attachment Bundle
- [SA5810](#) Medium Weight Tear Away Stabilizer
- [SA147](#) Brother Open Toe Clear Foot for sewing ribbon trim.
- Washable satin ribbon, one piece approximately 1/8-inch wide X 56-inches long to trim neck & sleeves.
- Temporary adhesive spray specifically for fabric
- Pattern, fabric, and notions for a basic tunic top. Be sure to choose a lightweight soft fabric for attractive sleeve ruffles. New Look® #6292 by Simplicity pattern Co. pattern is featured in this project. See **Figure #1**. Note the pattern modifications listed in step one below.

Figure #1



New Look® pattern is a product of Simplicity Pattern Company Inc., and Brother International Corporation makes no representations or warranties regarding such products.

- Additional yardage for circular sleeve ruffles: You need a piece of fabric measuring 12-inches square for each circular ruffle. This piece yields a ruffle approximately 16" long X 2½" wide, accommodating most pattern sizes. If you need a longer ruffle for your sleeve size simply make an additional circle and piece the ruffle for a longer length. When piecing, avoid a having a seam in the center. Instead, use one circle for the main, center section of the ruffle and add pieces at each end to achieve the necessary length.

Steps to Create Top with Circular Ruffles

1. This project includes several pattern hacks. A pattern hack simply means re-styling a pattern with some creative variations. Use the tunic pattern as is to fit as a top with ruffled sleeves, or follow all of the pattern hacks to create a swimsuit cover-up. Below are the creative changes made to turn this basic tunic pattern into a swimsuit cover-up with soft ruffles trimming the sleeves:
 - Select the main pattern pieces for this multi-sized pattern. View D neckline and sleeves are featured in this example. See **Figure #2a and #2b**. Measure as necessary and begin by determining your size for a standard blouse. Use cutting lines that match this size for the neck, shoulder, and armhole area. For a looser fit in the body cut one to two sizes larger in the bust, waist and hips. Be sure to cut sleeve to match the bust size you selected. Choosing to go up one or two sizes will depend on the fabric and your personal preference. When in doubt, size up and then baste pieces together to test the fit before proceeding with actual garment construction.

Figure #2a

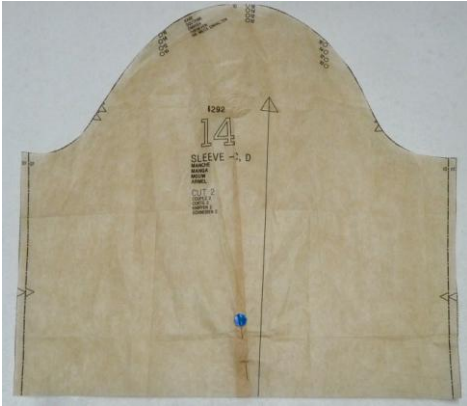

Figure #2b



- Lengthen front and back pattern pieces so tunic falls mid-thigh, taking care to include hem allowance. Shorten sleeves to fall just below your elbow or slightly longer if you wish. Remember, ruffle adds approximately 2-inches to the total sleeve length.
- Fold sleeve pattern at the bottom to form a ½" tuck, narrowing sleeve circumference slightly. Finish by straightening out the cutting line at the bottom of the sleeve. See **Figure #3**.

Figure #3



2. Next, cut all the required pieces according to the pattern instructions. Be sure to mark the pattern for notches, darts, etc.

Sewing Tips: Always test your markers for removability, especially before you iron over markings. If your fabric looks similar on both the right and wrong side it is a good idea to mark the wrong side of each piece with low tack tape. Keep patterns layered with matching fabric pieces until you use them to avoid confusion while constructing the garment.

3. Sew entire garment as directed in pattern instructions, leaving sleeves un-hemmed for the added ruffles. Be sure to clean finish all seam allowances to prevent raveling.

4. Stitch a self-faced ruffle for each sleeve as follows:

Cut a piece of tear away stabilizer to measure 12-inches square. Lightly spray with temporary adhesive. Place one fabric square right side up on top of the stabilizer. Add the second matching piece with right sides together and all edges matching. See **Figure #4**.

Figure #4



5. Attach circular sewing attachment to the machine. Please read the circular sewing attachment manual for detailed instructions if you are unfamiliar with this attachment. Place pivot point in the center of layered fabric squares. Smooth and pin the layers just outside the stitching area for the first circle. Secure squares to attachment. See **Figure #5**.

Figure #5



6. Select a center needle straight stitch using a 1.8 stitch length. Slowly sew circles on as follows:
- **Inner Circle:** Set indicator to 60mm. See **Figure #6**. Sew a complete inner circle, overlapping stitches slightly at the end.
 - **Outer Circle:** Set indicator to 130-mm. Sew a complete outer circle overlapping stitches slightly at the end. See **Figure #7**.

Figure #6

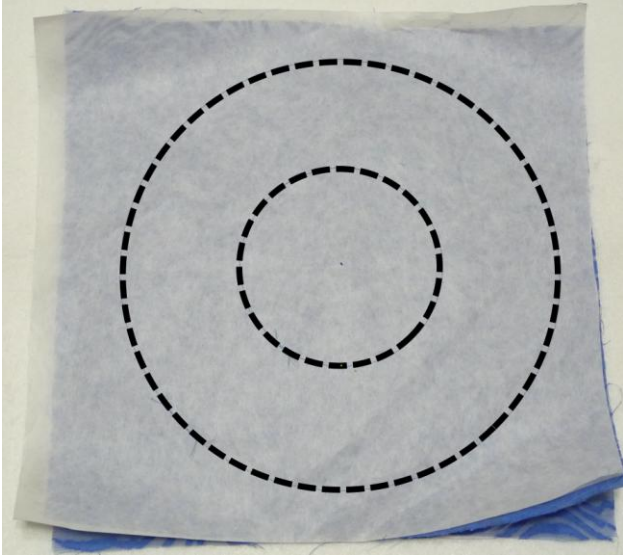

Figure #7



7. Remove fabric from attachment. Repeat steps for next set of circles.

8. Flip the circle over and carefully remove all of the tear away from each circle. See stitching lines highlighted below:



9. To complete each ruffle first cut around the outer circle, leaving a scant $\frac{1}{4}$ -inch seam allowance beyond the stitching line. Next, cut away the inner circle cutting along the stitching line to completely remove the stitches. Finally, cut a straight slit through the closed circle to create an opening. It is best to cut in an area with the straight of grain. See **Figure #8**.

Figure #8



10. Going forward, handle the ruffle carefully to avoid stretching it out of shape. Turn circles right side out and press carefully.

11. For each sleeve you will need to straighten out the circle and line it up with the un-hemmed edge of the sleeve to determine cutting length. Cut ruffle length to match sleeve. See dashed red lines in **Figure #9.**

Figure #9

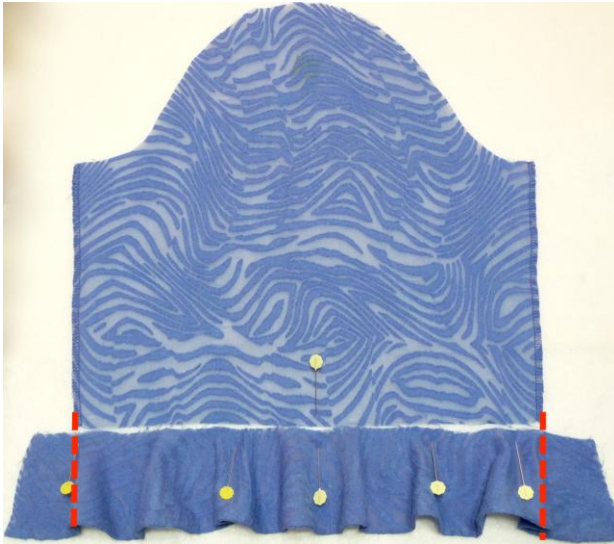

Note: If sleeve opening is larger than finished ruffle, sew an additional circle and piece together before finishing and attaching to sleeve edge.

12. Set up machine for standard sewing. Sew each ruffle into a continuous circular piece to attach to lower edge of sleeves as follows:

- Open out short raw edges, matching seam lines.
- Pin so raw edges match and then sew a seam allowance (5/8-inch) that matches the seam allowance for the sleeve seams. Press gently. See **Figure #10a & 10b.**

Figure #10a

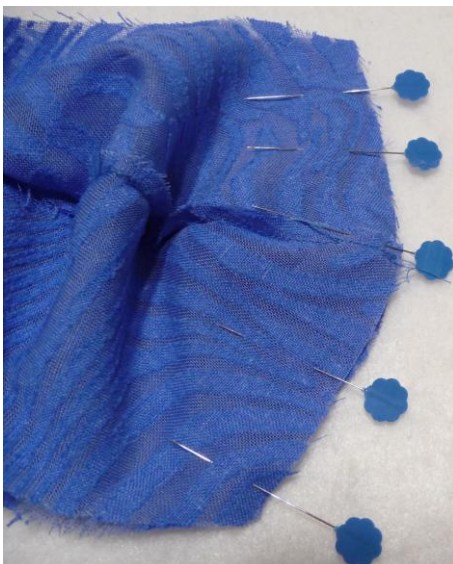
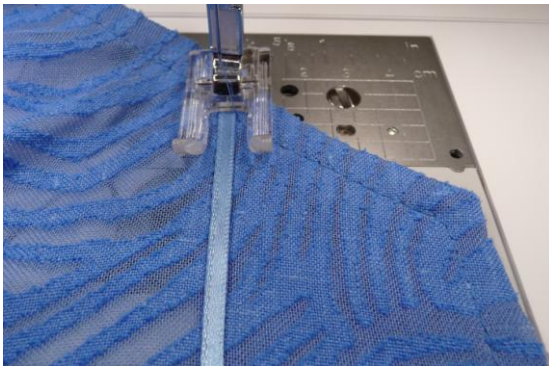
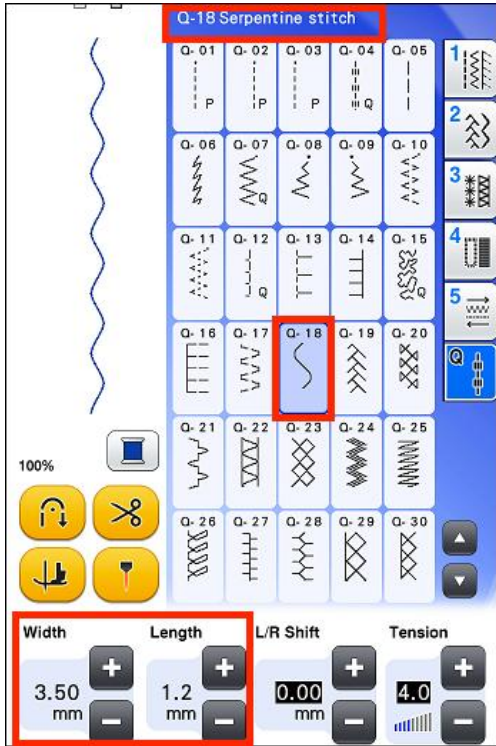

Figure #10b



13. Sew sleeve seam and set sleeves into armholes. Using a 3/8-inch seam allowance, pin and then sew a circular ruffle to hem edge of each sleeve, matching ruffle seam with sleeve seam and having all raw edges even.
14. Add narrow ribbon to the outside front placket, sewing the ribbon along the edge of the finished placket.

Tip: Use a serpentine stitch to catch the ribbon without additional bulk. See examples below:



1. Sew remaining ribbon to the sleeve, sewing ribbon just above the ruffle. Attach small pieces to accent the elbow area if desired.



Additional Resources:

- Visit the Brother web site at www.brother-usa.com for additional Free embroidery designs, project instructions, tutorials, and more! Sign up for their monthly newsletter and you'll get notifications for special offers, free embroidery designs and other valuable information.
- Visit your local [Brother sewing machine dealer](#) for Brother Machines, Brother software programs, and special machine accessories.
- Please visit me at my Sewing and Embroidery website, www.letsdosew.com for more tips, techniques, video lessons and free downloads. Sign up for updated sewing ideas and inspiration, project ideas, and more when you visit www.letsdosew.com.
- Find me on Facebook - <https://www.facebook.com/letsdosew/>

Happy Sewing!

Joanne